

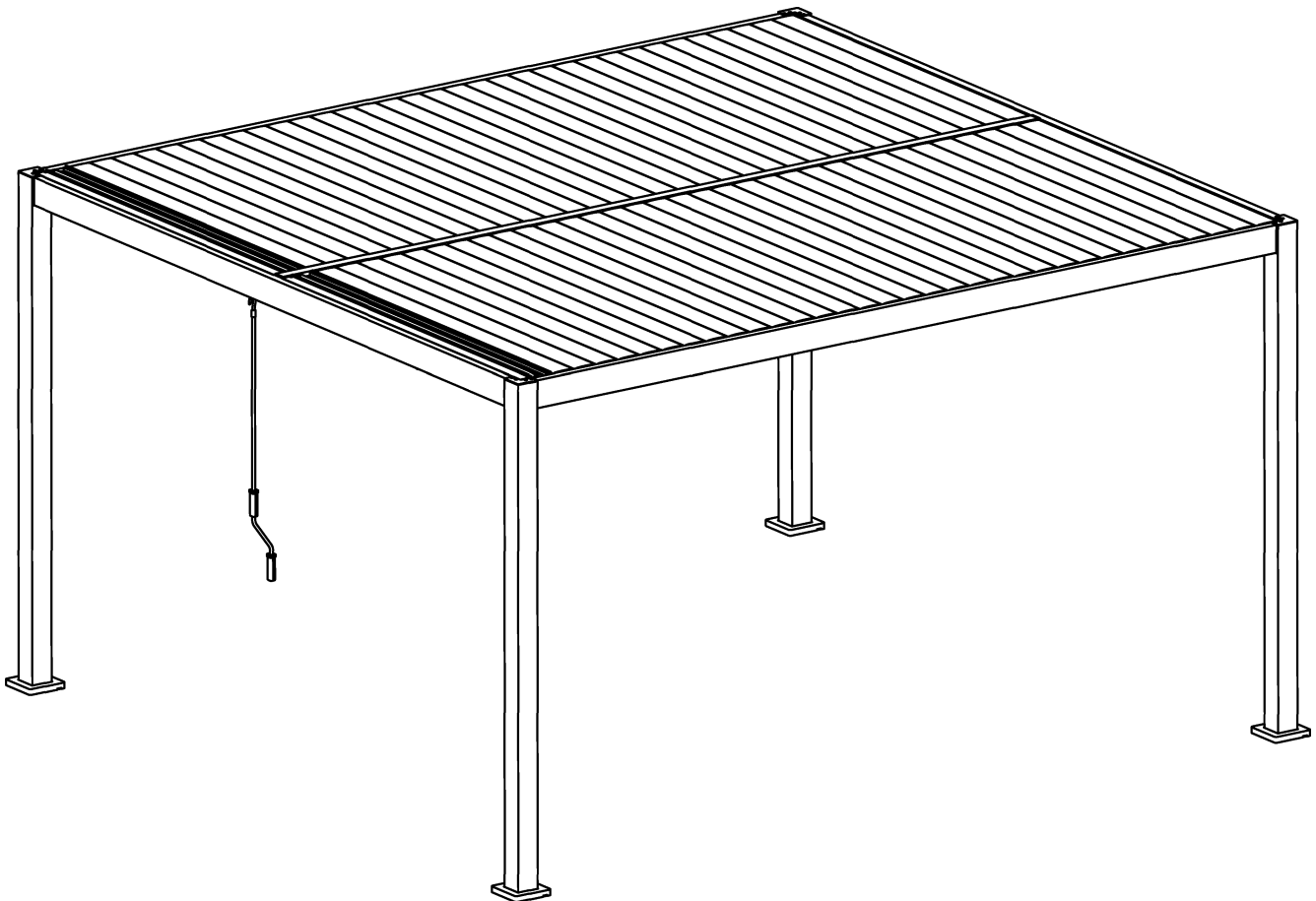

ROYCE CUBE BIOCLIMATIC PERGOLA. Assembly Instruction Manual for 3M x 3M











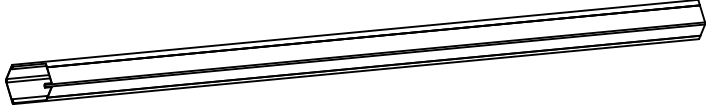

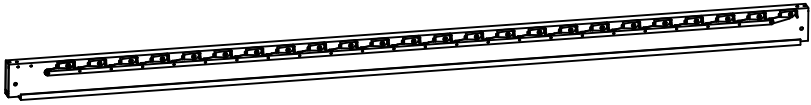

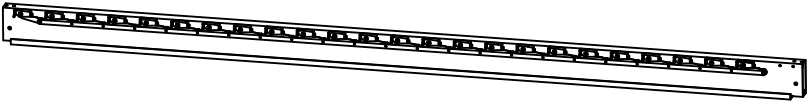

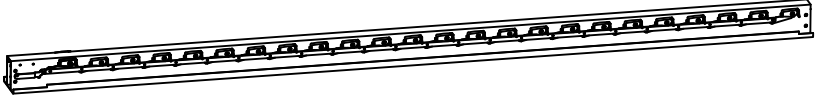

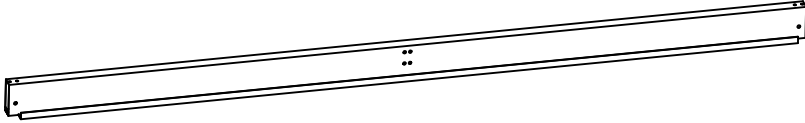
Welcome to your new Royce Cube Pergola. Here is your step-by-step installation guide. Before we start here is a reminder of the features to your new Pergola:



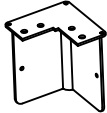
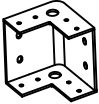
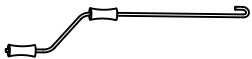

- Full aluminium construction with strengthened uprights.
- Double skinned louvres for added strength and noise reduction
- Deep gutter system to the roof which drain naturally through the uprights.
- Manually operated independant opening and closing louvres.
- 5 Year Manufacturers Warranty on main structure
- 2 Year Manufacturers Warranty on CUBE Pull Down Screens and LED Lights













Have a question about your Royce Cube Pergola?
Scan me to find out more. Or go to www.roycecube.co.uk

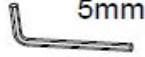
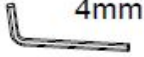
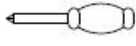

PART NO	DESCRIPTION	QTY	PART NAME
A	 	4	Leg
B	 	1	Outer edge beam
C	 	1	Outer edge beam
D	 	1	Centre beam
E	 	2	End beam
F	 	2	Fixed louvre
G	 	48	Roof louvre
H		4	Corner cap
I		4	Beam connector
J		1	Winding handle
K		2	Middle beam fitting
L		1	Louvre mechanism
M		1	Louvre mechanism

PART NO	DESCRIPTION	QTY	PART NAME
N	 M5*18	2	Winding ring
O		4	End louvre bracket
P		4	Foot plate
Q		4	Foot plate cover

PART NO	DESCRIPTION	QTY	PART NAME
AA	 M6*20	16	
BB	 M6*15	24	
CC	 M6*10	16	
DD	 M6*15	8	
EE	 M6*35	4	
FF	 M5*12	16	
GG	 M5*12	12	
HH		8	
II	 5mm  4mm	3	
JJ		1	
KK	 M6*13	2	

Components and fixings are included.

Should you require any replacement parts please complete our Parts Request Form at: www.norfolkleisurelifestyle.com/contact-us



Please retain this information with your proof of purchase for future reference. We recommend reading through the instructions carefully before you start.

Important

The Royce Cube Pergola should be assembled on a level area.

We recommend that the installation of your Royce Cube Pergola is carried out by an experienced person.

Please read through the instructions first before you start.

You will need 2 persons to complete the assembly which will take approximately 4-6 hours.

First remove all the components and fittings and place them on a clean area to protect from damage. Check that you have all the parts (see Parts List) before you start.

Care and Maintenance

The Royce Cube Pergola is a permanent structure and should be left assembled throughout the year. We recommend that fixings are checked at the start of the season to ensure they are tight.

During high winds it is recommended to raise the Pull Down Screens and open the louvres to help avoid any structural damage.

Warranty

The main structure carries a 5 Year Limited Warranty against manufacturing defects and faults. Cube Pull Down Screens and LED lights 2 Years Limited Warranty.



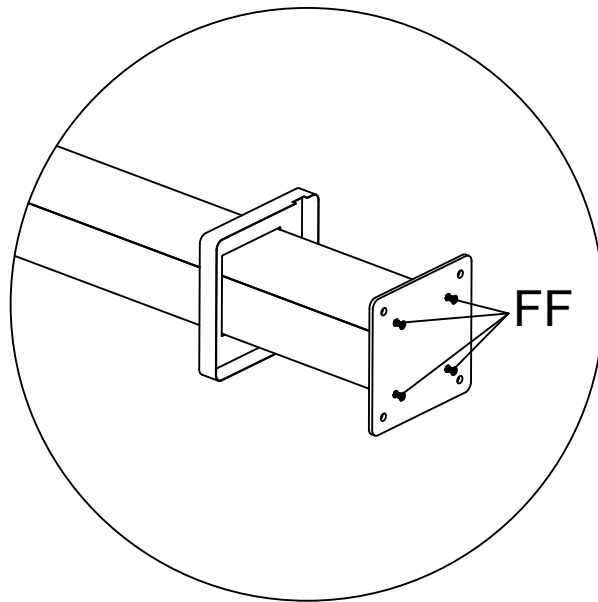
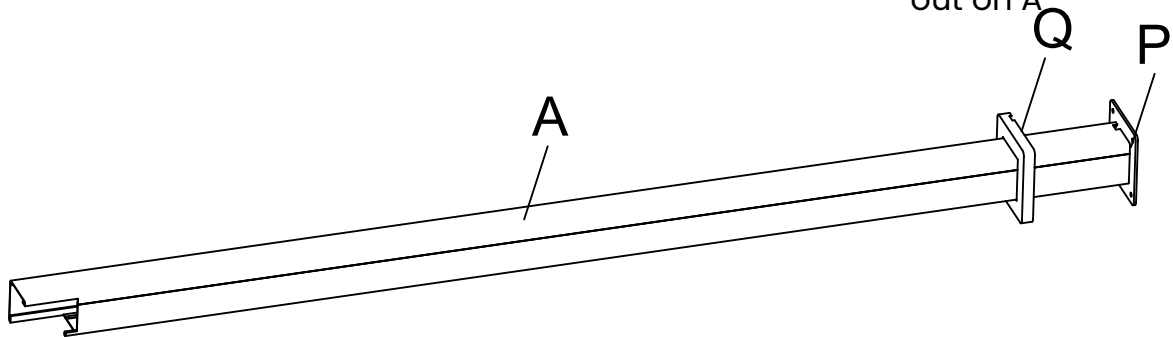

If you should need to make a claim, please contact your stockist in the first instance with your proof of purchase and details of your claim.

Step 1

Ensure that the cut out on Q is the same as the cut out on A



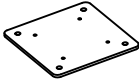

Parts

A	4		Q	4	
P	4		FF	16	 M5*12

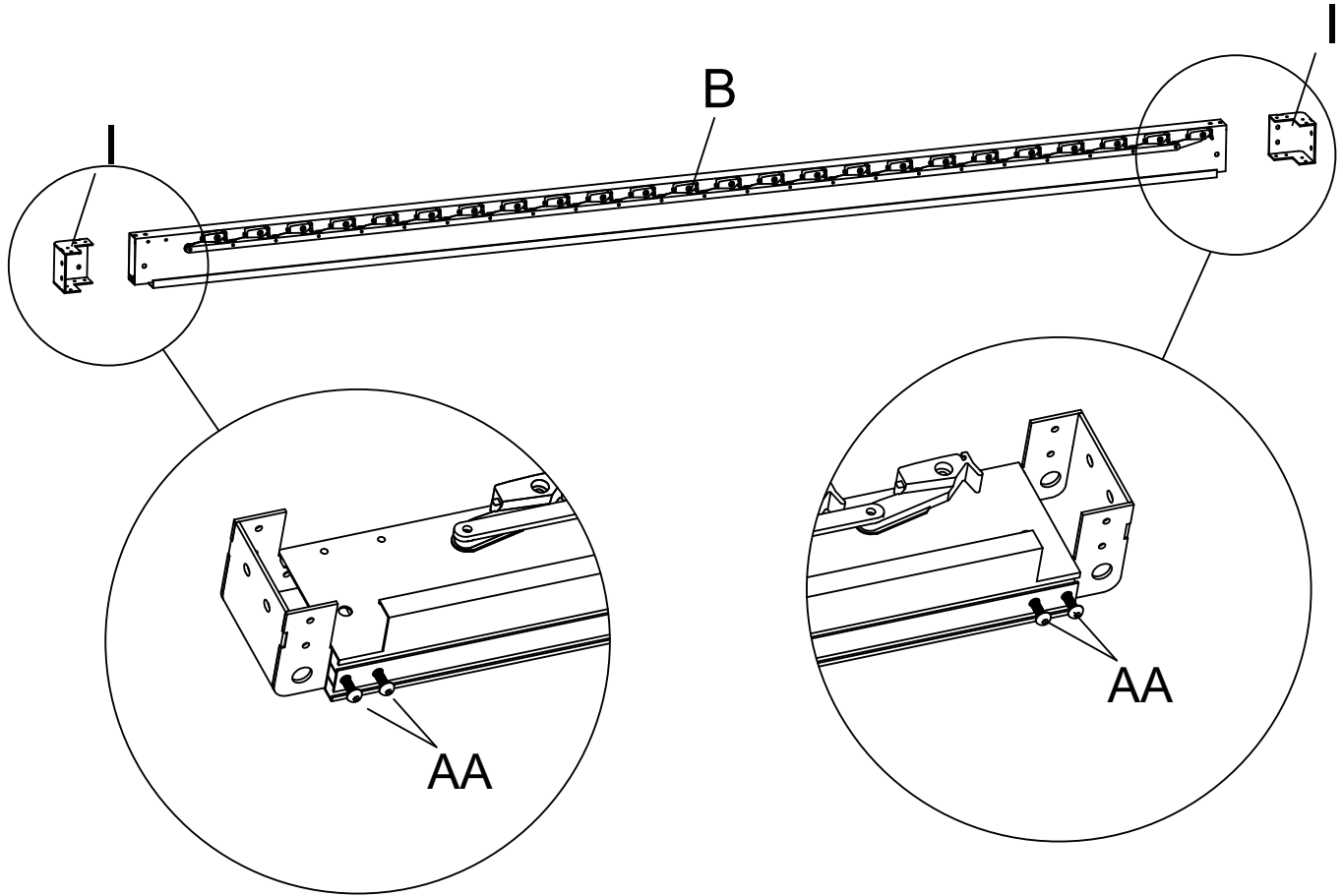
Step 2



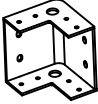

Parts

B	1		AA	4	 M6*20
I	2				

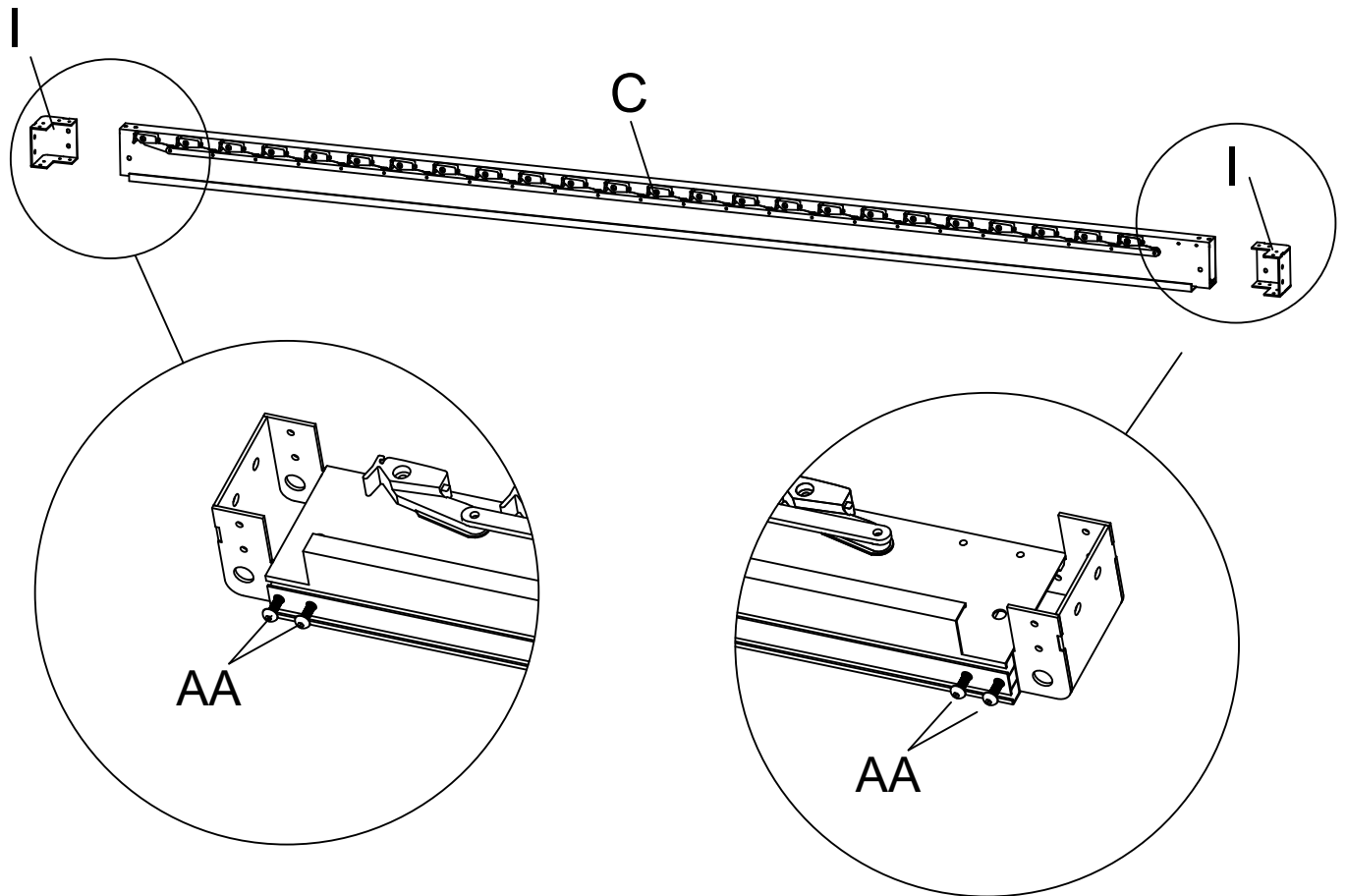
Step 3





Parts

C	1		AA	4	 M6*20
I	2				

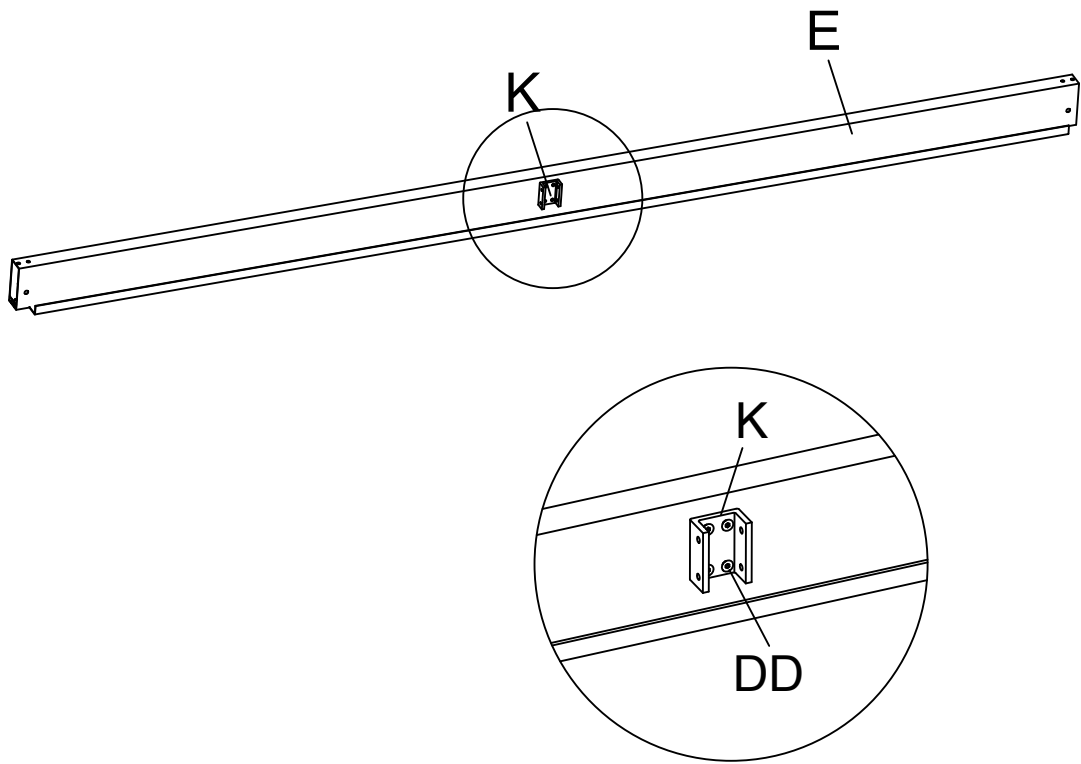
Step 4

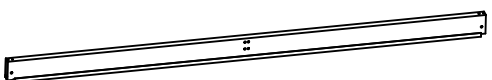

Parts

E	2		DD	8	 M6*15
K	2				

Step 5

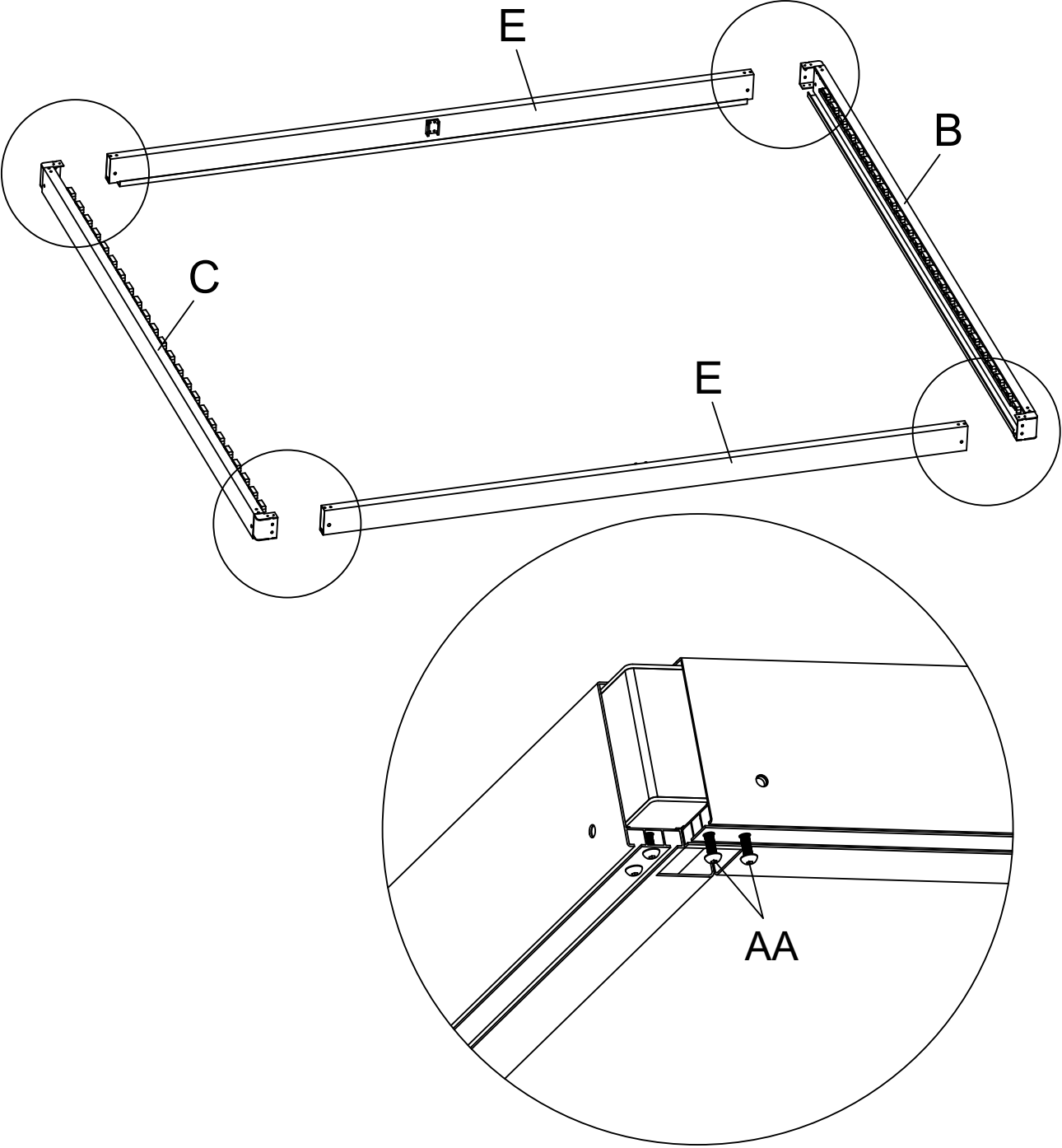

Parts

AA	8	 M6*20
----	---	---

Step 6

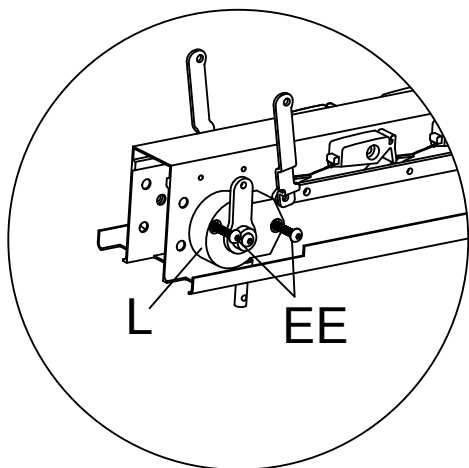
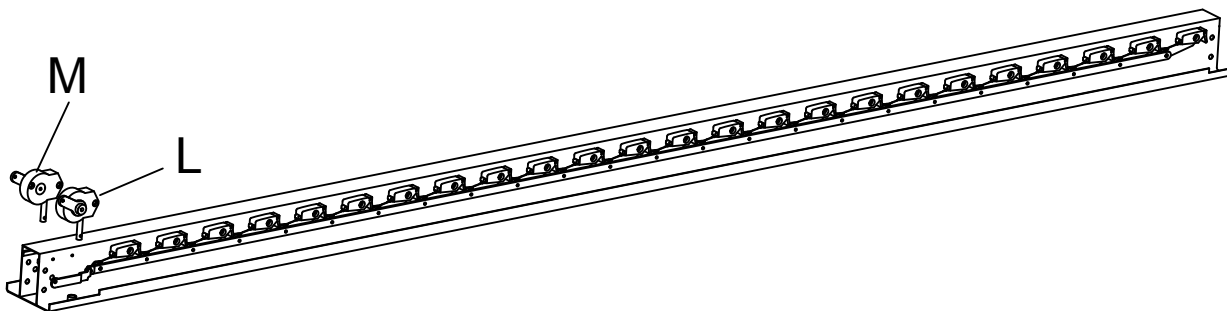

6

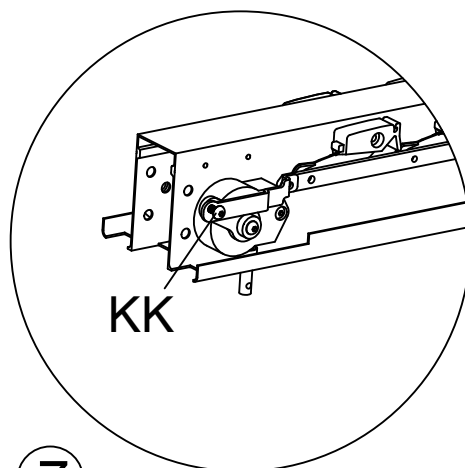

7

Insert the screwdriver through the hole in the lower part of the louvre mechanism (Part L & M) and rotate the arm to an upright position.

Parts

D	1		KK	2	M6*13
L	1		EE	4	M6*35
M	1				

Step 7

Please note: Make sure you keep the plastic part in the tube facing in the same direction

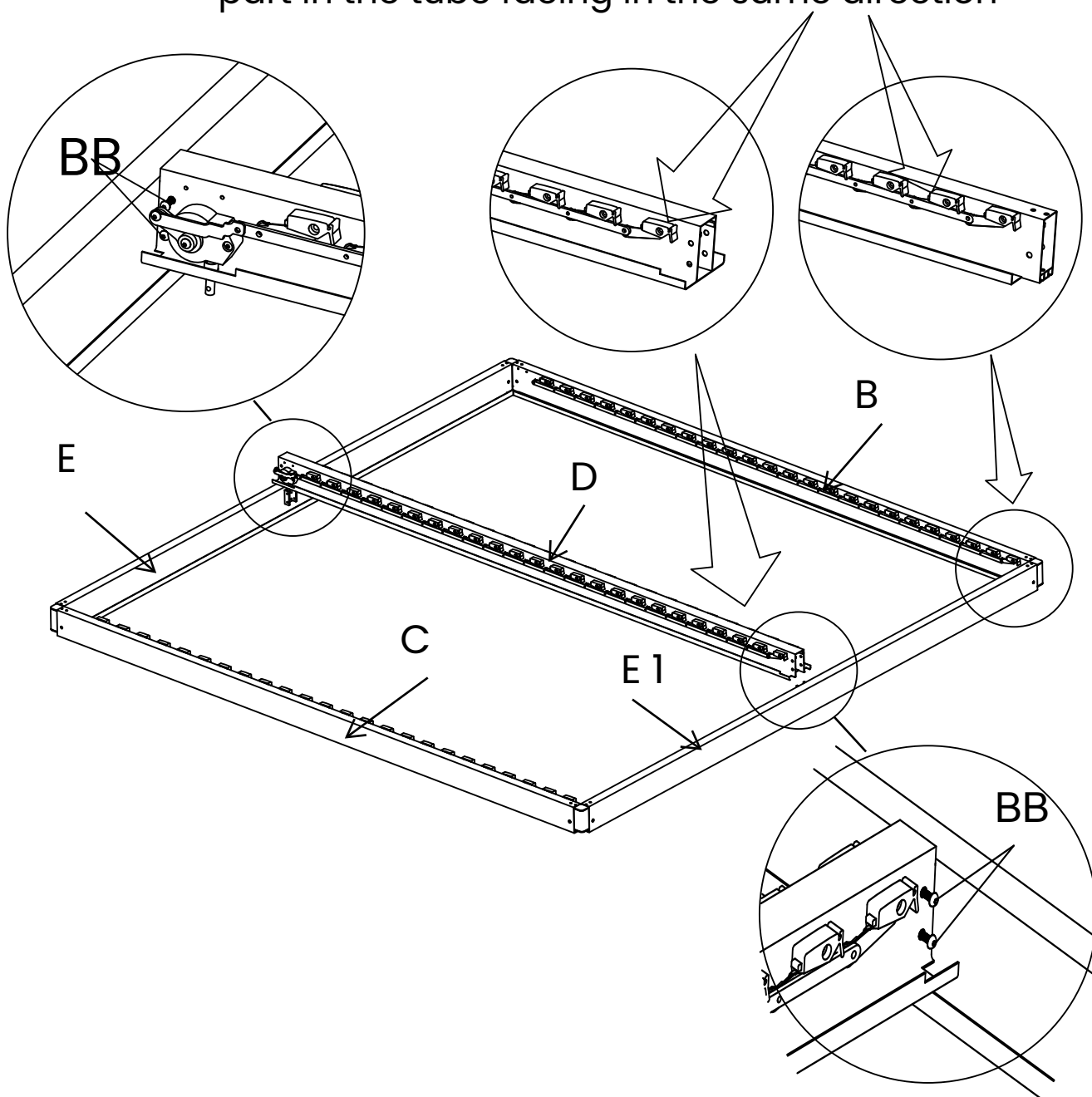



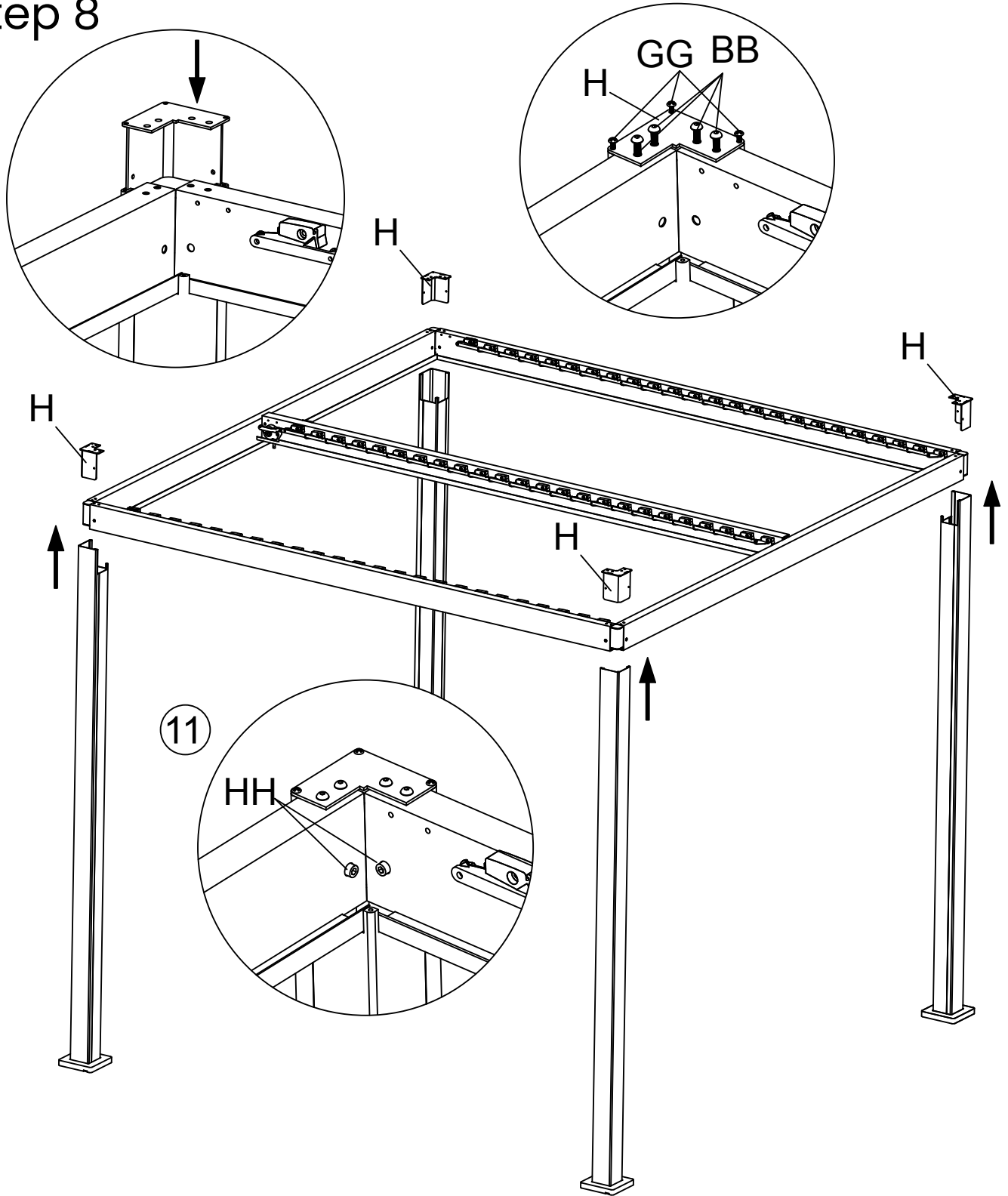

Parts

BB	8	 M6*15
----	---	---

Step 8

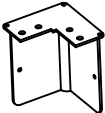

Parts

H	4		BB	16	 M6*15
HH	8		GG	12	 M5*12

Step 9

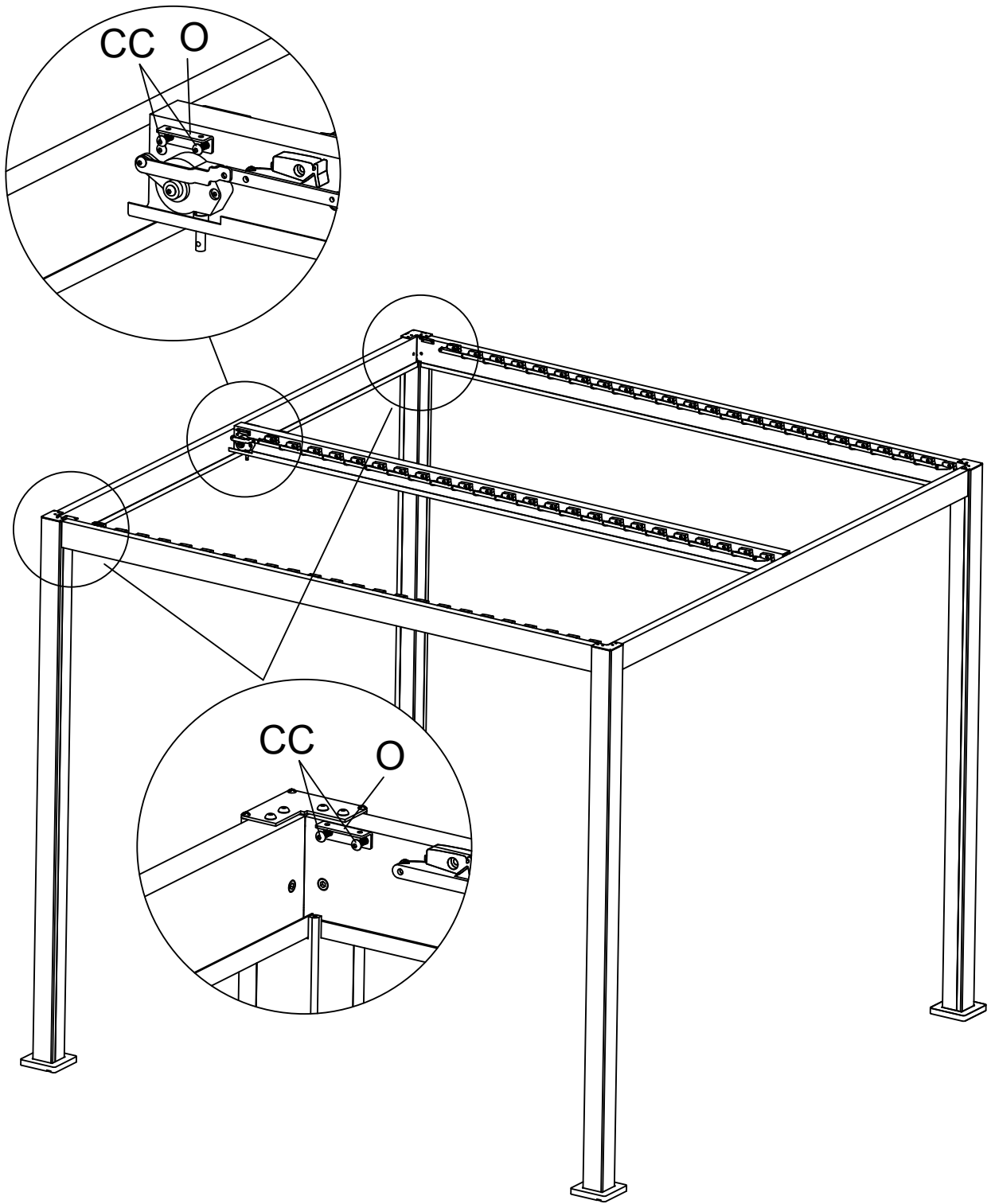

Parts

O	4		CC	8	 M6*10
---	---	---	----	---	---

Step 10

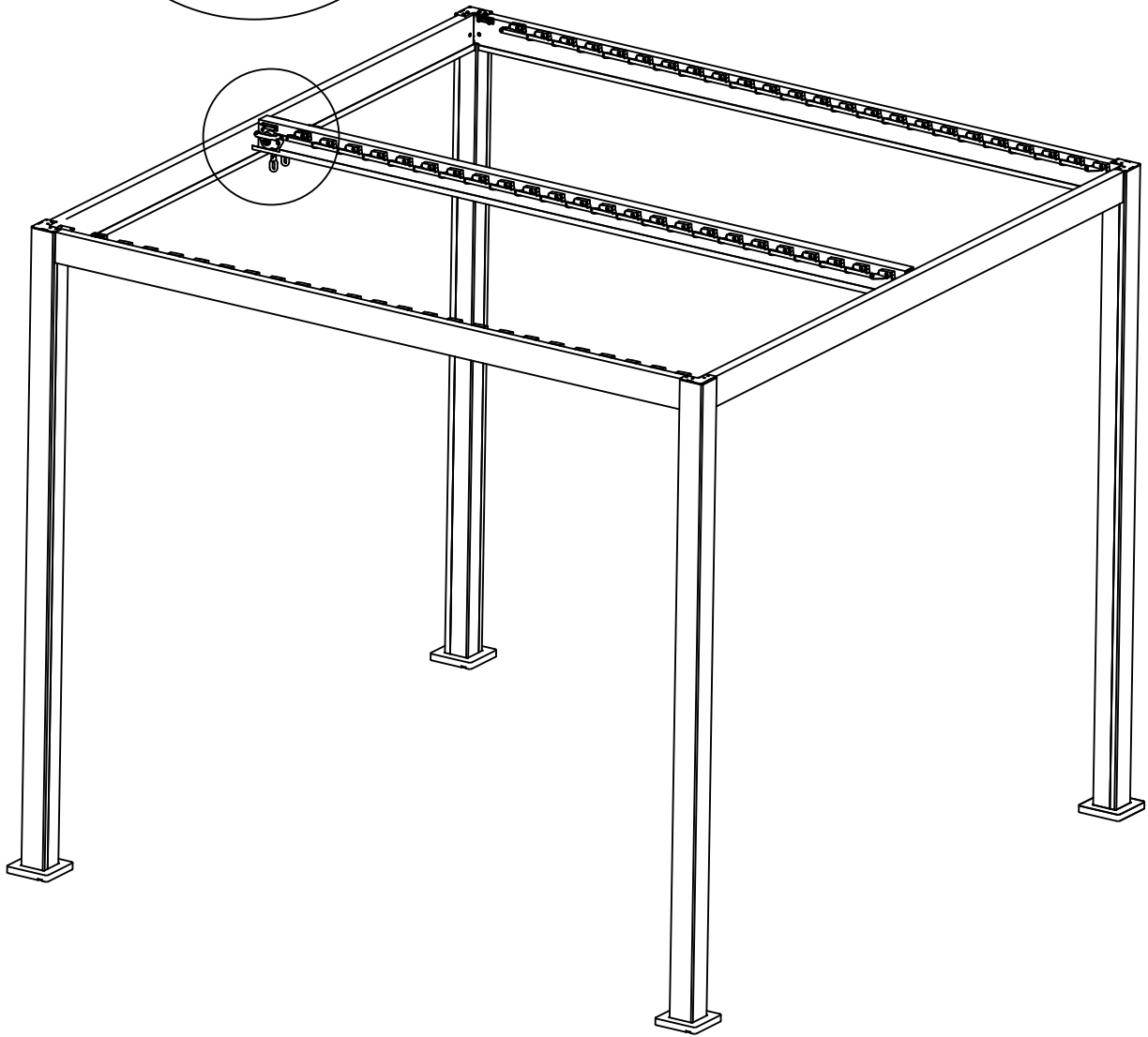
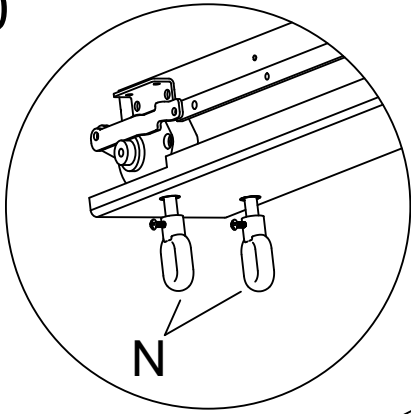

Parts

N	2		 M5*18
---	---	---	--

Step 11

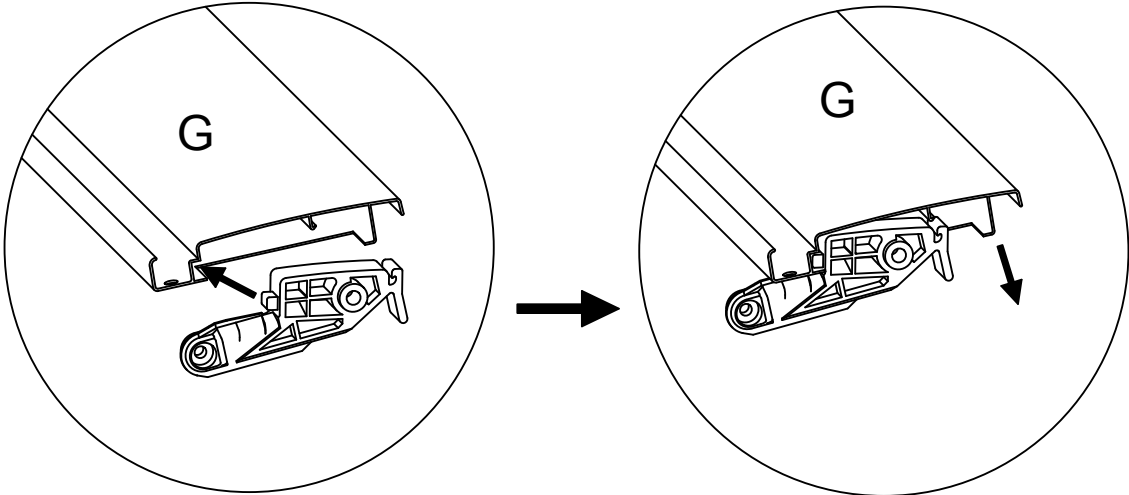
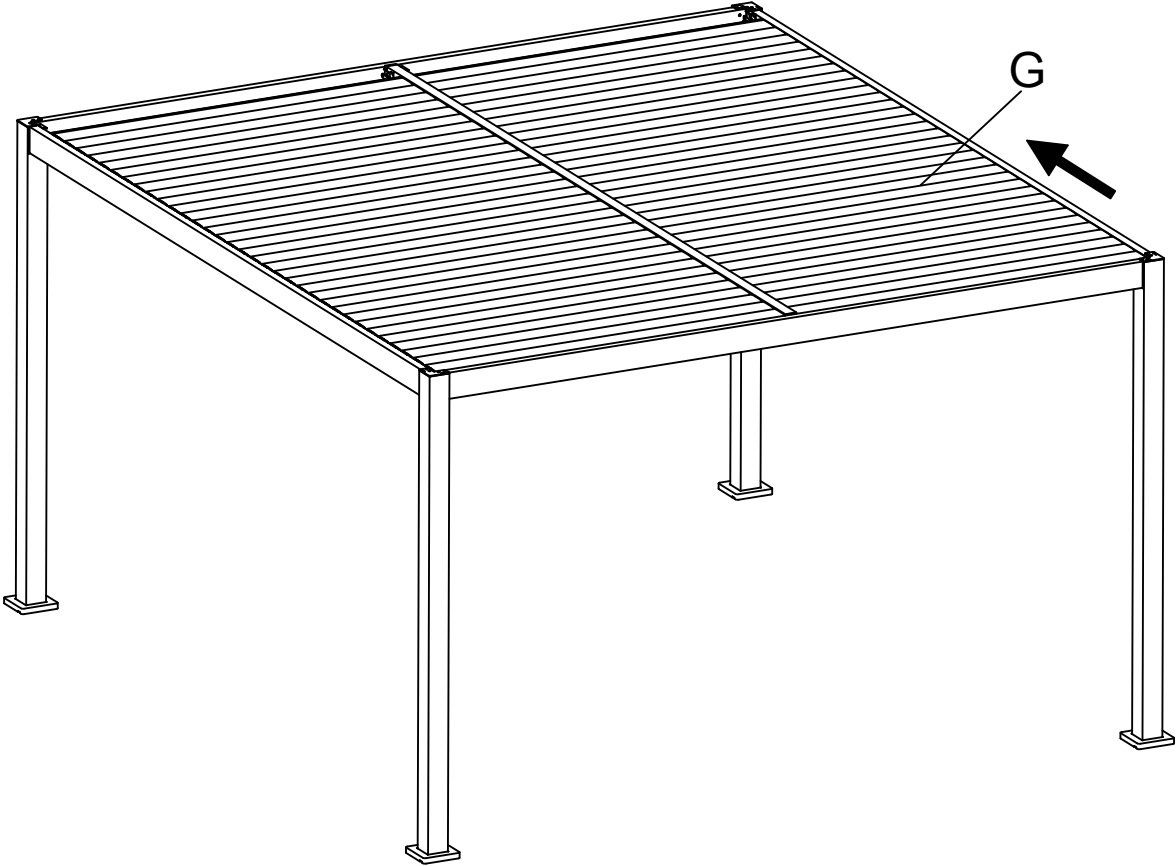



Parts

G	48	
---	----	---

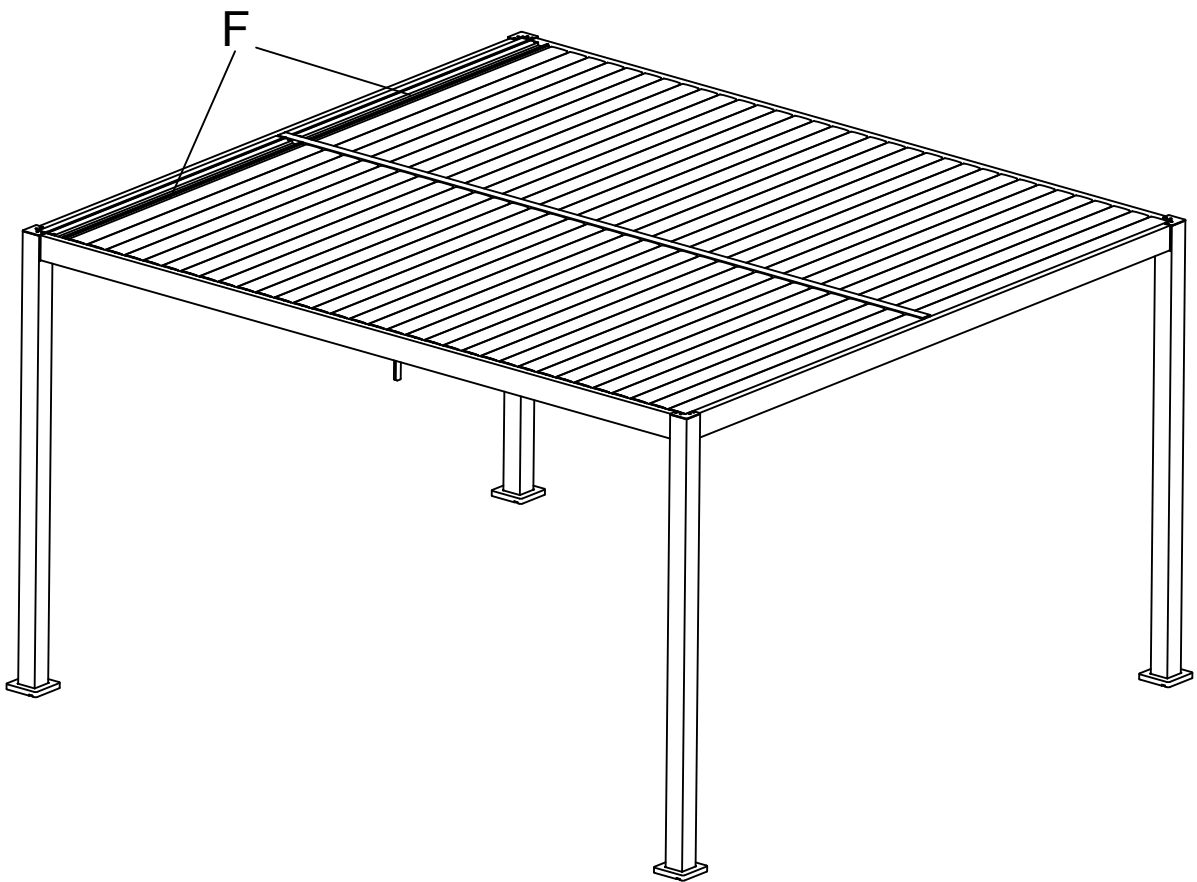
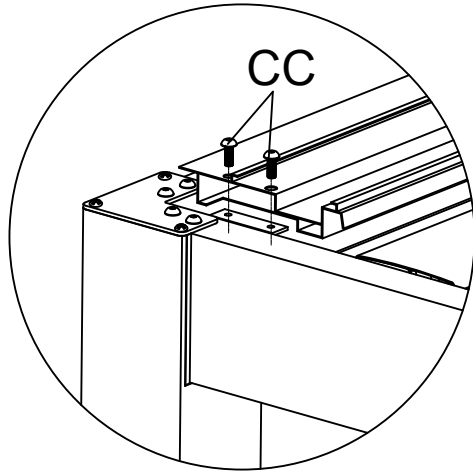
Step 12



Parts

F	2		CC	8	 M6*10
---	---	---	----	---	---